

4.25"
(3.75")

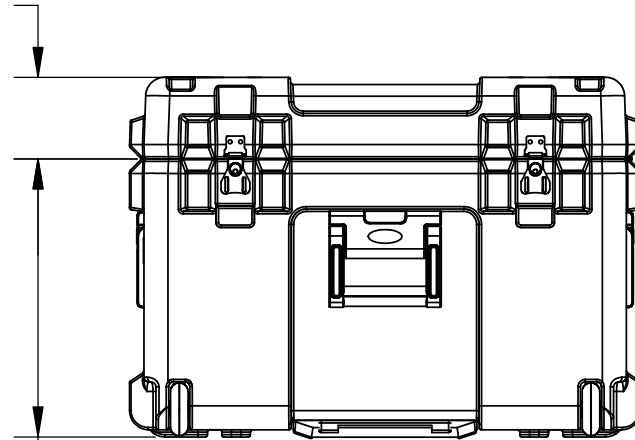

14.49"
(13.48")

3R2423-17



434 West Levers Place
Orange, CA 92867
Phone: (714) 637-1252
Fax: (714) 637-0491
<http://www.skbcases.com>

This drawing and all information details are the sole property of SKB Corporation, Orange CA. Any unauthorized use will be punished to the full extent of the law.

Case Series:	Mil - Standard	Dimensions (for reference only)			
		Length	Width	Overall	Base / Lid
Case part#	3R2423-17				
		left to right	front to back	height	height
Weight:	30.9 LBS EMPTY	27.75"	26.58"	18.74"	14.48"-4.25"
		Exterior			
		Interior	24.00"	23.00"	17.23"
					13.48"-3.75"

NOTE: DIMENSIONS IN (X.XX") ARE ID

5

4

3

2

1